



Toplift 55
Truck Crane
Datasheet
metric

























Toplift 55

PRELIMINARY



WORKS FOR YOU.™

	Page:
Key	
.....	3
Dimensions and Specifications	
Crane Dimensions	4
Specifications	5
Range Diagram	6
Load Charts	
.....	7
Technical Descriptions	
Lifting Capacity	9
Boom and Components	9
Jib	9
Winch Performance	9
Crane Boom Function Speeds	10
Outrigger Function Speeds	10
Outrigger Controls	10
Engine and Transmission	10
Hydraulics	11
Chassis and Components	11
Driver Cab	11
Operator Cab	11

	Counterweight		Main hoist
	Outrigger		Auxiliary hoist
	Radius		Hoist speed
	Main boom		Cab
	Boom length		Engine
	Boom with extension		Steering
	Boom angle		Travel speed
	Tip height		Hydraulics
	Hook block		Transmission
	Slewing / Allowable swinging range		Load limiter / Load indicator
	Working speeds		Air conditioning / Cab heating
	Working temperature		Gradeability – road

CRANE DIMENSIONS

Toplift 55

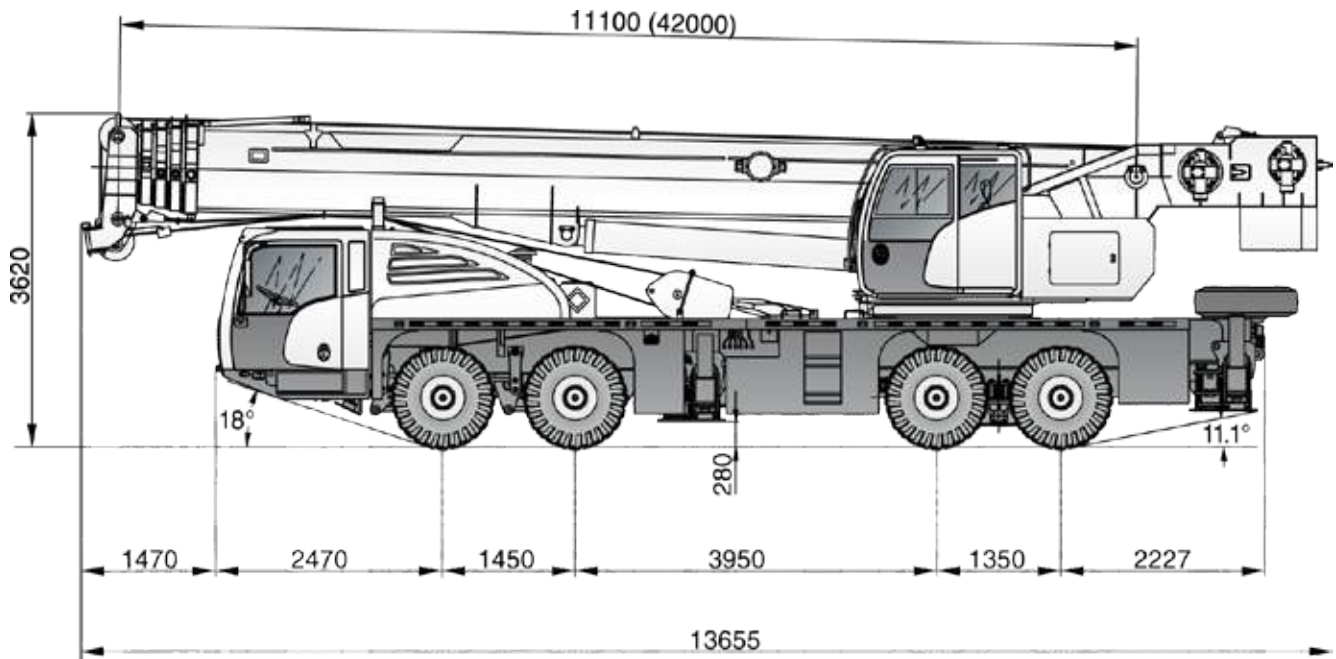

Crane Weights

Gross vehicle weight (GVW)	41,880 kg
----------------------------	-----------

Axle Loads

Steering axles (axle 1 and 2)	15,940 kg
Drive axles (axle 3 and 4)	25,940 kg

Ground Clearances

Minimum ground clearance	280 mm
Ramp angle	18.0°
Approach angle	18.0°
Departure angle	11.5°

Wheel Base

Distance between axle 1 and 2	1,450 mm
Distance between axle 2 and 3	3,950 mm
Distance between axle 3 and 4	1,350 mm

Wheel Track

Axle 1 and 2	2,280 mm
Axle 3 and 4	2,056 mm

Outrigger Dimensions

Longitudinal span	5.8 m
Transverse span	7.2 m

Outrigger Forces

Maximum counterforce	525 kN
----------------------	--------





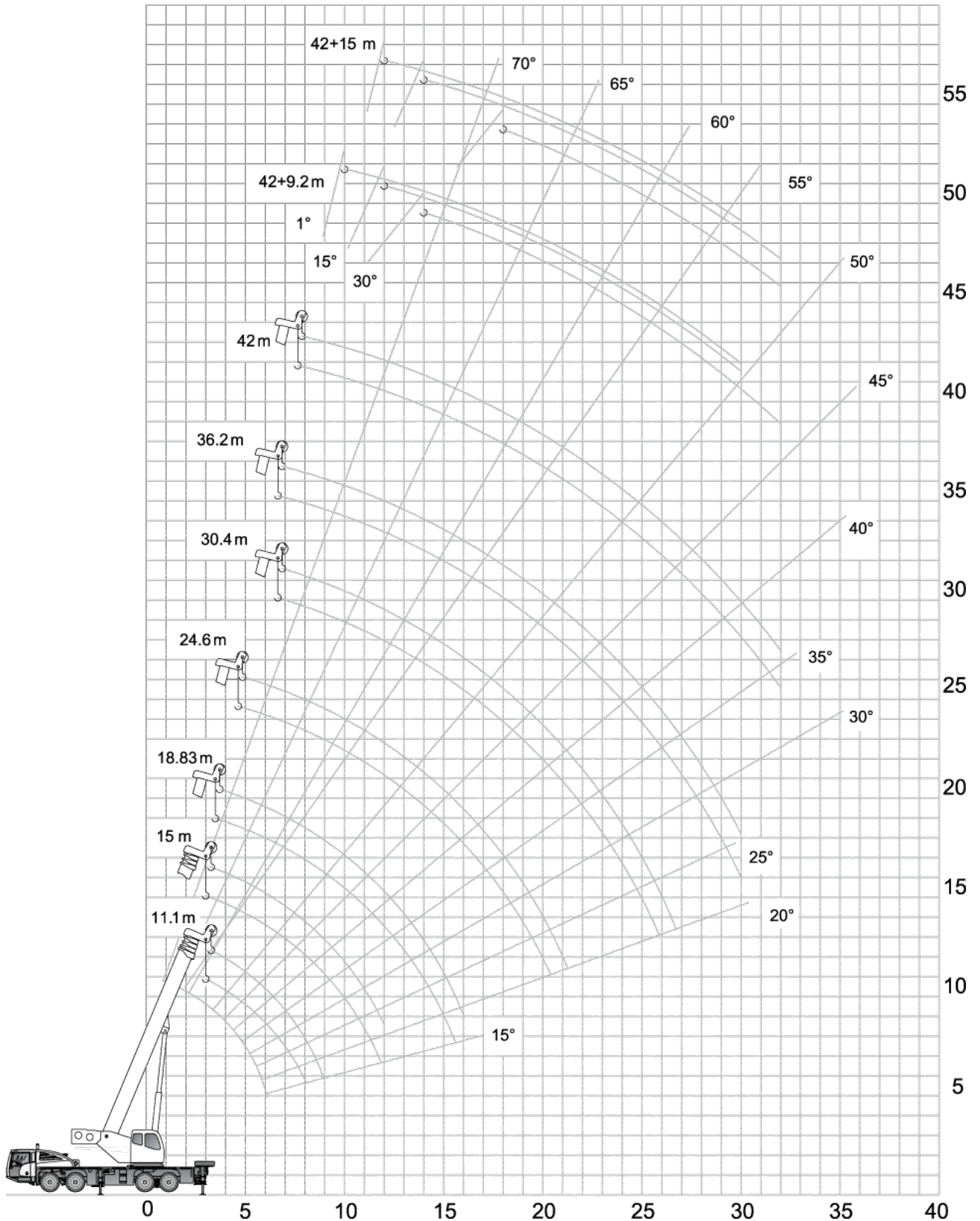

Overall Dimensions

(Length x Width x Height)	13.655 m x 2.80 m x 3.62 m
---------------------------	----------------------------

RANGE DIAGRAM

Toplift 55



 Fully extended (100%)		 360°						
	 11.1 m	 15.0 m	18.83 m	24.6 m	30.4 m	36.2 m	42.0 m	
m	kg							m
3	55000	40000	-	-	-	-	-	3
3,5	50500	40000	33200	-	-	-	-	3,5
4	44500	40000	33200	24000	-	-	-	4
5	36000	34500	29300	22600	-	-	-	5
6	31000	30000	26000	20000	16600	-	-	6
7	26000	25500	24000	18300	15200	13000	-	7
8	20300	19700	19400	16600	13800	12000	-	8
9	15800	15500	15500	15200	12600	11200	9000	9
10	-	12500	12500	13700	11400	10200	9000	10
11	-	9900	9900	11000	10800	9400	8500	11
12	-	8300	8300	9500	9900	8900	8000	12
14	-	-	5800	6800	7450	7900	6800	14
16	-	-	4000	5000	5650	6100	6000	16
18	-	-	-	3750	4350	4800	5000	18
20	-	-	-	2800	3350	3700	4000	20
22	-	-	-	2000	2550	2950	3200	22
24	-	-	-	-	1900	2300	2600	24
26	-	-	-	-	1400	1800	2050	26
28	-	-	-	-	950	1350	1600	28
30	-	-	-	-	-	950	1200	30
32	-	-	-	-	-	-	900	32
Parts of Line	12	8	8	6	4	4	3	Parts of Line
min. 	0°	0°	0°	0°	11°	29°	37°	min. 

Notes

The values in table are rated lifting capacities of crane on solid ground and in a level state. The working radius in the table are actual radius after load lifting.

While lifting with boom length of 11.1 m each section must be fully retracted.

The tabulated load ratings includes weight of hooks, main hook is 543 kg and auxiliary hook is 102 kg. While the jib is in extension state, the rated load capacity lifted by main boom must be reduced by 1500 kg.

When the main hook is at the head of main boom: lifting with jib, the lifting capacities of jib must be reduced by 543 kg; When working with head pulley, the rated lifting capacities at each section must be reduced by 543 kg, but max. lifting capacities is 4000 kg; Using main hook when auxiliary hook at the head of pulley of the boom tip, the rated lifting weight of each part of lifting boom should be reduced by 102 kg.

When the fifth outrigger is not in use, no lifting in front of 120° range. On the fifth outrigger, according to the tabulated rated lifting capacities in 360° range.

If the boom length exceeds the specified values, comparing it's capacities with the next longer one's, the load to the lift will be with in the smaller one's.

The bottom column in the table lists all min. boom angle of elevation in various boom length elevating the boom below the corresponding min. angle of elevation is strictly forbidden.

Fully extended (100%)				360°			
°	42 m + 9.2 m			42 m + 15 m			°
	1°	15°	30°	1°	15°	30°	
	kg			kg			
78	4000	2700	2400	2500	1400	1100	78
75	3600	2500	2300	2100	1250	1000	75
72	3200	2300	2200	1800	1150	990	72
70	2900	2200	2100	1700	1100	950	70
65	2300	2000	1900	1400	950	850	65
60	1800	1600	1500	1100	800	750	60
55	1000	1000	900	800	700	650	55

Notes

The values in table are rated lifting capacities of crane on solid ground and in a level state. The working radius in the table are actual radius after load lifting.

While lifting with boom length of 11.1 m each section must be fully retracted.

The tabulated load ratings includes weight of hooks, main hook is 543 kg and auxiliary hook is 102 kg. While the jib is in extension state, the rated load capacity lifted by main boom must be reduced by 1500 kg.

When the main hook is at the head of main boom: lifting with jib, the lifting capacities of jib must be reduced by 543 kg; When working with head pulley, the rated lifting capacities at each section must be reduced by 543 kg, but max. lifting capacities is 4000 kg; Using main hook when auxiliary hook at the head of pulley of the boom tip, the rated lifting weight of each part of lifting boom should be reduced by 102 kg.

When the fifth outrigger is not in use, no lifting in front of 120° range. On the fifth outrigger, according to the tabulated rated lifting capacities in 360° range.

If the boom length exceeds the specified values, comparing it's capacities with the next longer one's, the load to the lift will be with in the smaller one's.

The bottom column in the table lists all min. boom angle of elevation in various boom length elevating the boom below the corresponding min. angle of elevation is strictly forbidden.

Lifting Capacity

	Maximum rated capacity for main hook	55 t
	Maximum rated capacity for auxiliary hook	4 t
	Maximum load moment	1823 kN.m





Boom and Components

	Profile	Decagonal
	Number of sections	5
	Base boom length	11.1 m
	Base boom maximum lift height	11.044 m
	Base boom maximum working radius	9 m
	Fully extended boom length	42 m
	Fully extended boom maximum lift height	42.14 m
	Fully extended boom maximum working radius	32 m

Jib

	Fully extended boom and jib length	57 m
	Fully extended boom maximum lift height with jib	56.835 m
	Fully extended boom maximum working radius with jib	36 m
	Slewing speed	1.77 rpm



Winch Performance

	 Main hoist – 3rd layer – single rope speed	0-110 m/min
	 Auxiliary hoist – 3rd layer – single rope speed	0-110 m/min

Crane Boom Function Speeds

	Elevation – up	55 sec
	Elevation – down	70 sec
	Full extension	100 sec
	Full retract	88 sec

Outrigger Function Speeds

 	Simultaneous full extension	60 sec
	Simultaneous full retract	30 sec

Outrigger Controls

	Dual outrigger controls – LH and RH side	Dual control
	Ambient working temperature	-20 °C – +40 °C

Engine and Transmission

	Chassis Engine:	
	Weichai power	WP 10.336N
	Emission compliance	National Exhaust Standard III
	Number of cylinders	6
	Aspiration	Turbocharged
	Rated power	247 kW @ 2200 rpm
	Maximum torque	1500 Nm @ 1300 – 1600 rpm
	Estimated fuel consumption per 100 km	49 L
	Fuel type	Diesel
	Fuel tank capacity	350 L
Lowest start temperature	-30 °C	
	Manual gearbox with ZF style air-boosted shifting	Manual air-boosted shift

Hydraulics

	Load sensing hydraulic system	Load sensing
	Combined system with dual pump	Double pump
	Hydraulic controls: Pilot actuated multi-axis joystick controls	Pilot joystick

Chassis and Components

	Axle drive system	8 x 4
	Fifth outrigger for 360° boom operation	Fifth outrigger
	Minimum turning radius	12 m
	Maximum gradeability	48 %
	Maximum traveling speed	80 km/h

Driver Cab

	Adjustable driver seat
	Adjustable steering wheel
	Airconditioner and heater

Operator Cab

	Adjustable seat
	Load moment limiter display
	Airconditioner and heater

Effective Date: February 2013. Product specifications and prices are subject to change without notice or obligation. The photographs and/or drawings in this document are for illustrative purposes only. Refer to the appropriate Operator's Manual for instructions on the proper use of this equipment. Failure to follow the appropriate Operator's Manual when using our equipment or to otherwise act irresponsibly may result in serious injury or death. The only warranty applicable to our equipment is the standard written warranty applicable to the particular product and sale and Terex makes no other warranty, express or implied. Products and services listed may be trademarks, service marks or trade-names of Terex Corporation and/or its subsidiaries in the USA and other countries. All rights are reserved. Terex® is a registered trademark of Terex Corporation in the USA and many other countries.

Copyright 2013 Terex Corporation

Terex Cranes, Global Marketing, Dinglerstraße 24, 66482 Zweibrücken, Germany
Tel. +49 (0) 6332 830, Email: info.cranes@terex.com, www.terexcranes.com



www.terexcranes.com

Brochure Reference: TC-DS-M-E-Toplift 55 - 02.13



WORKS FOR YOU.™